

Features

- High luminous Flux LEDs
- 4.8mm Straw Standard Directivity
- Superior Weather-resistance
- UV Resistant Epoxy
- Water Clear Type

Applications

- Backlighting (illuminated advertising etc.)
- Substitution of Micro Incandescent Lamps
- Reading Lamps / Emergency Lighting
- Marker lights (e.g. steps, exit ways, etc.)
- Other Lighting

Outline Dimension

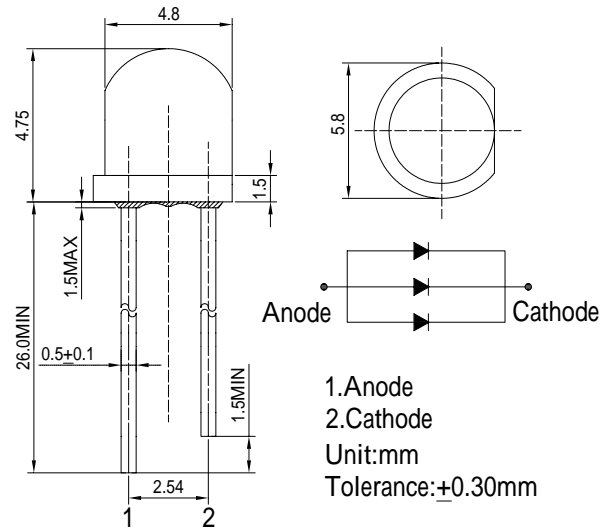

Absolute Maximum Rating

(Ta=25 °C)

Item	Symbol	Value	Unit
DC Forward Current	I _F	75	mA
Pulse Forward Current*	I _{FP}	360	mA
Reverse Voltage	V _R	5	V
Power Dissipation	P _D	270	mW
Operating Temperature	T _{opr}	-30 ~ +85	
Storage Temperature	T _{stg}	-40 ~ +100	
Lead Soldering Temperature	T _{sol}	260 /5sec	-

*Pulse width Max 10ms , Duty ratio max 1/10

Directivity

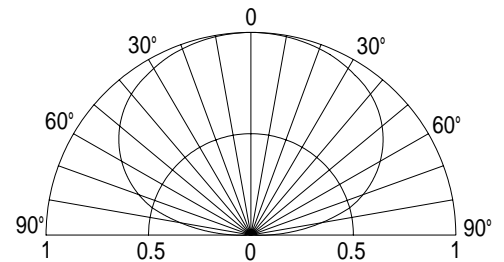

Electrical -Optical Characteristics

(Ta=25 °C)

Item	Symbol	Condition	Min.	Typ.	Max.	Unit
DC Forward Voltage	V _F	I _F =60mA	2.9	3.1	3.6	V
DC Reverse Current	I _R	V _R =5V	-	-	30	μA
Luminous Flux	v	I _F =60mA	-	25	-	lm
Color Temperature	CCT	I _F =60mA	-	6500	-	K
Chromaticity Coordinates*	x	I _F =60mA	-	0.31	-	
	y	I _F =60mA	-	0.33	-	
50% Power Angle	2θ _{1/2}	I _F =60mA	-	150	-	deg

*1 Tolerance of chromaticity coordinates is ±10%

*2 Tolerance of luminous intensity is ±15%