

AX22X4



Acriche series is designed for AC source operation and high flux output applications.

Acriche is a semi-permanent and Environmental.

Friendly semiconductor lighting that can be used in AC without additional device.

Acriche's thermal management perform exceeds other power LED solutions.

It incorporates state of the art SMD design and Thermal emission material.

Acriche is ideal light sources for general illumination

Applications.

AX22X4

Features

- Connect directly in AC
- Power Saving
- Long Life Time
- Simple BOM
- Miniaturization
- Low thermal resistance
- SMT solderability
- Lead Free product
- RoHS compliant

Application

- Architectural lighting
- Task lighting
- Decorative / Pathway lighting
- Household appliances

* The appearance and specifications of the product can be changed for improvement without notice.

Part number of AX22X4

1. Part Number form : A X₁ X₂ X₃ X₄ X₅

X ₁	Color
W	Pure White
N	Warm White

X ₂	Acriche Series
2	A2

X ₃	LENS Type
2	Dome Type

X ₄	Operating Voltage [V]
0	100
1	110

X ₅	PCB Type
0	Emitter
4	PCB

Outline dimensions

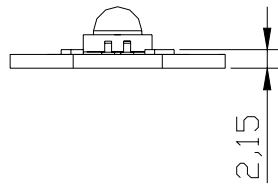
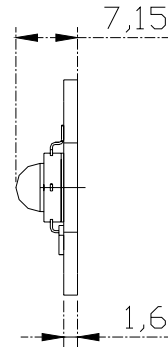
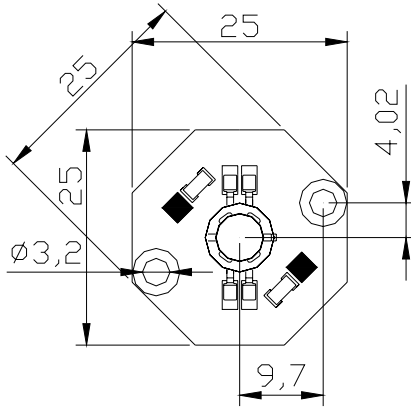

Notes :

1. All dimensions are in millimeters. (tolerance : ± 0.2)
2. Scale : none
3. This drawing without tolerances are for reference only
4. Slug of package isn't connected to anode or cathode

Characteristics of Acriche

1. Pure white – AW2204, AW2214

1-1 Electro-Optical characteristics at 100V/110V RMS, $T_A=25^{\circ}\text{C}$

Parameter	Symbol	Value			Unit
		Min	Typ	Max	
Luminous Flux ^[1]	Φ_V ^[2]	-	80	-	lm
Illuminance ^[3]	Φ_l		91		lux
Correlated Color Temperature ^[4]	CCT	-	6300	-	K
CRI	R_a	-	70	-	-
Operating Current	I_{opt}	-	20	-	mA[RMS]
Power Dissipation	P_D	2			W
Operating Frequency	Freq	50 / 60			Hz
View Angle	2θ 1/2	110			deg.

1-2 Absolute Maximum Ratings

Parameter	Symbol	Value	Unit
Operating Voltage	V_{opt} ^[5]	115/127	V [RMS]
Power Dissipation	P_D	4.3	W
Junction Temperature	T_j	125	$^{\circ}\text{C}$
Operating Temperature	T_{opr}	-30 ~ +85	$^{\circ}\text{C}$
Storage Temperature	T_{stg}	-40 ~ +120	$^{\circ}\text{C}$
ESD Sensitivity	-	$\pm 2,000\text{V}$ HBM	-

*Notes :

- [1] Acriche series maintains a tolerance of $\pm 10\%$ on flux and power measurements.
- [2] Φ_V is the total luminous flux output as measured with an integrated sphere.
- [3] Illuminance is measured at 50cm distance
- [4] Correlated Color Temperature is derived from the CIE 1931 Chromaticity diagram.
CCT $\pm 5\%$ tester tolerance
- [5] 'Operating Voltage' doesn't indicate the maximum voltage which customers use, but it means tolerable voltage according to the voltage variation rate by one's country.
It is recommended that the temperature of lead frame should be below 70°C .



Characteristics of Acriche

2 Warm white – AN2204, AN2214

2-1 Electro-Optical characteristics at 100V/110V RMS, $T_A=25^{\circ}\text{C}$

Parameter	Symbol	Value			Unit
		Min	Typ	Max	
Luminous Flux ^[1]	Φ_V ^[2]	-	65	-	lm
Illuminance ^[3]	Φ_l		73		lux
Correlated Color Temperature ^[4]	CCT	-	3000	-	K
CRI	R_a	-	70	-	-
Operating Current	I_{opt}	-	20	-	mA[RMS]
Power Dissipation	P_D	2			W
Operating Frequency	Freq	50 / 60			Hz
View Angle	2θ 1/2	110			deg.

2-2 Absolute Maximum Ratings

Parameter	Symbol	Value	Unit
Operating Voltage	V_{opt} ^[5]	115/127	V [RMS]
Power Dissipation	P_D	4.3	W
Junction Temperature	T_j	125	$^{\circ}\text{C}$
Operating Temperature	T_{opr}	-30 ~ +85	$^{\circ}\text{C}$
Storage Temperature	T_{stg}	-40 ~ +120	$^{\circ}\text{C}$
ESD Sensitivity	-	$\pm 2,000\text{V}$ HBM	-

*Notes :

- [1] Acriche series maintains a tolerance of $\pm 10\%$ on flux and power measurements.
- [2] Φ_V is the total luminous flux output as measured with an integrated sphere.
- [3] Illuminance is measured at 50cm distance
- [4] Correlated Color Temperature is derived from the CIE 1931 Chromaticity diagram.
CCT $\pm 5\%$ tester tolerance
- [5] 'Operating Voltage' doesn't indicate the maximum voltage which customers use, but it means tolerable voltage according to the voltage variation rate by one's country.
It is recommended that the temperature of lead frame should be below 70°C .

Color spectrum, Ta=25°C

1. Pure white

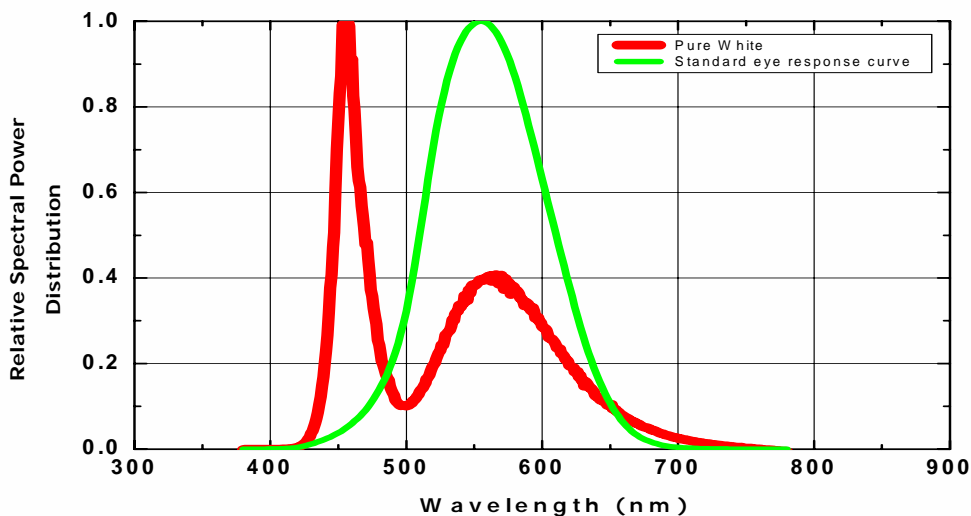

2. Warm white

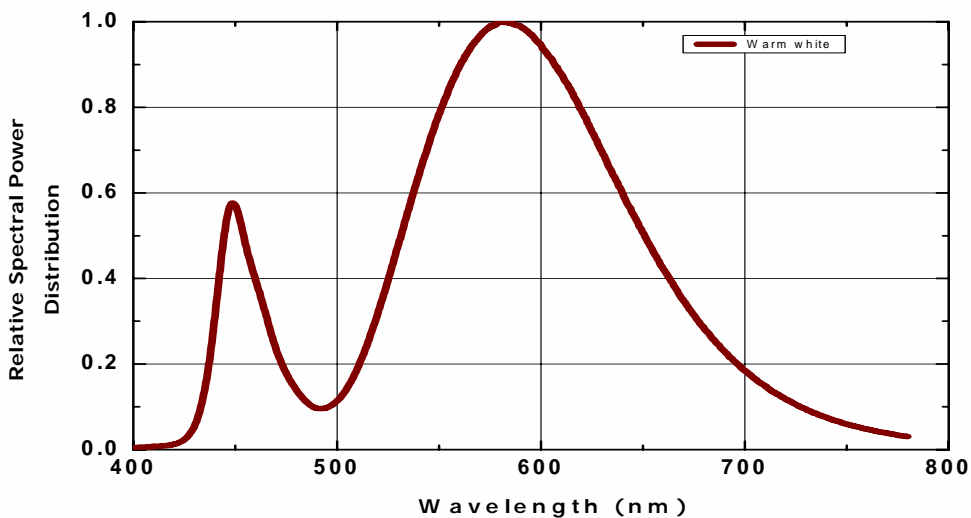

Current – Voltage characteristics, Ta=25°C

1. Current[RMS] vs Voltage[RMS] - 100V

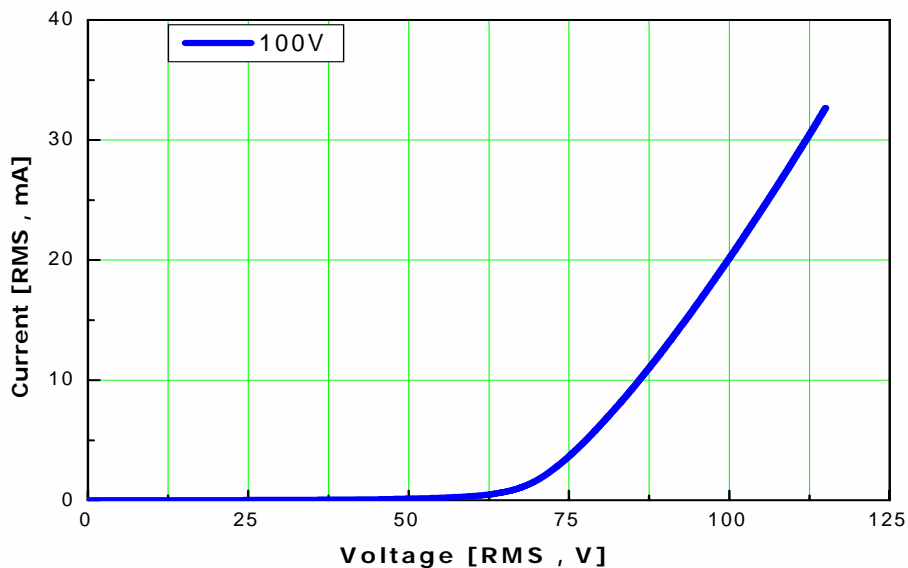

2. Current[RMS] vs Voltage[RMS] - 110V

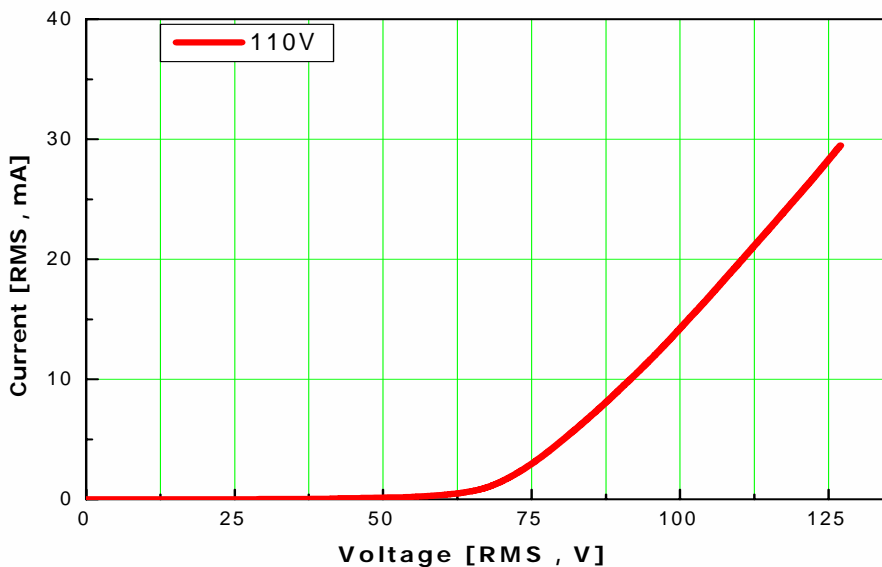

Voltage – Relative flux characteristics, Ta=25°C

1. Voltage[RMS] vs. Normalized Relative Luminous Flux -100V

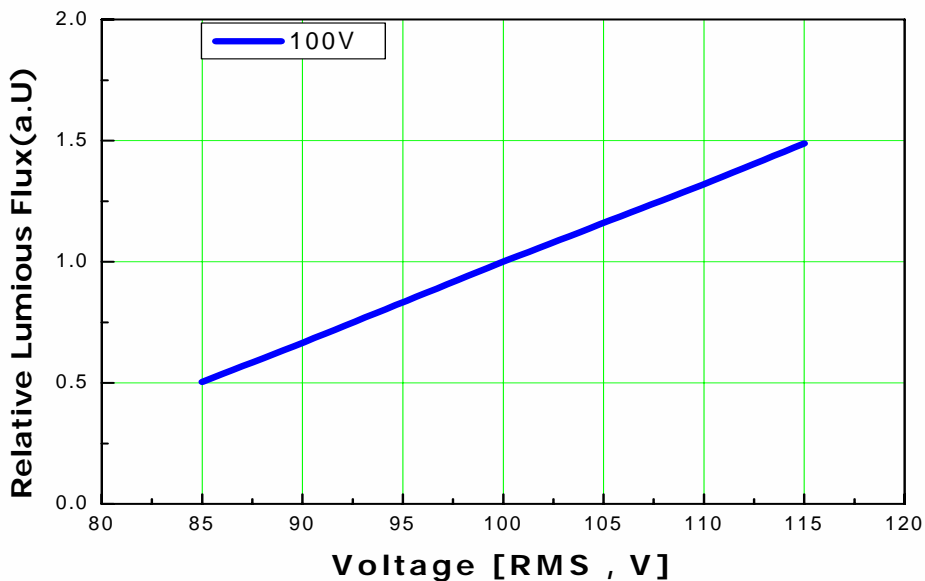

2. Voltage[RMS] vs. Normalized Relative Luminous Flux -110V

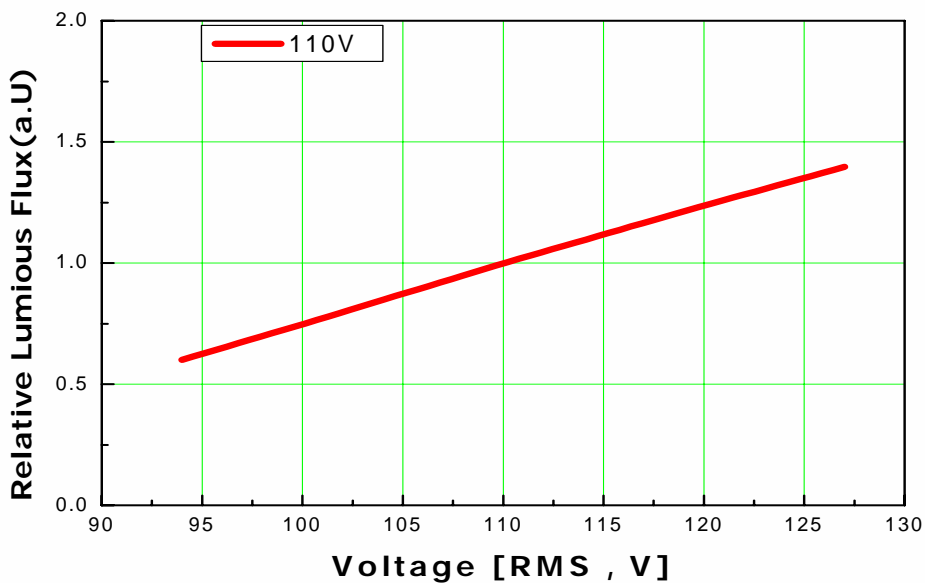

Voltage – XY Coordinate Shift, Ta=25°C

1. Voltage[RMS] vs. XY Coordinate Shift -100V

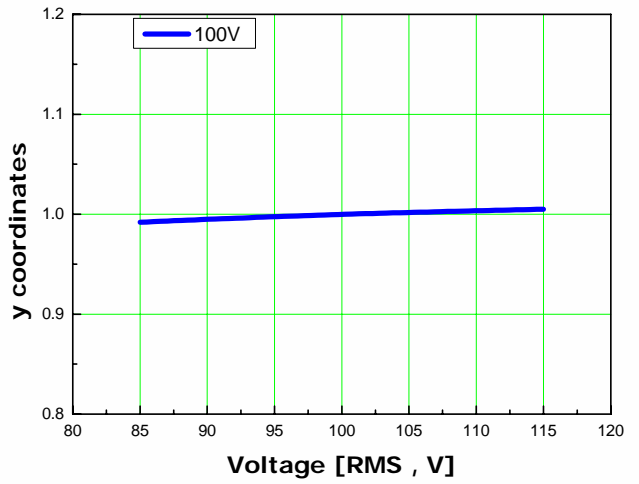
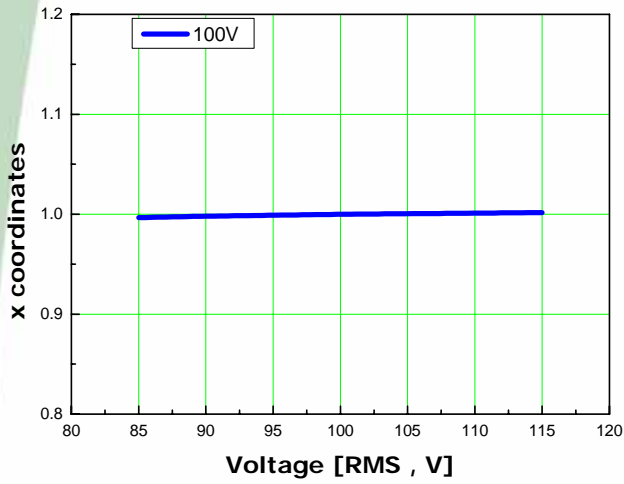

2. Voltage[RMS] vs. XY Coordinate Shift -110V

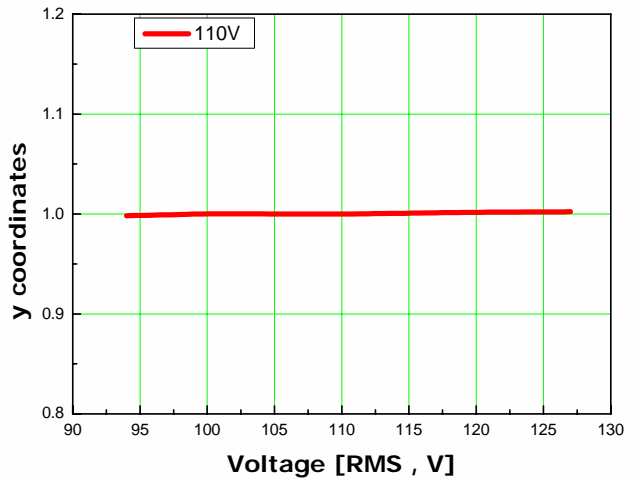
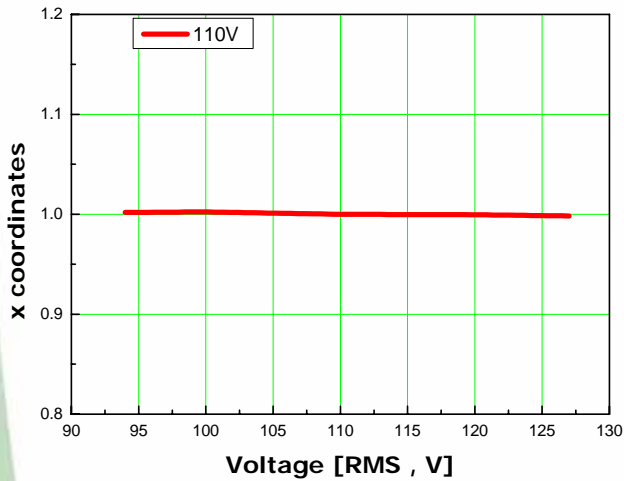

Voltage - Color Temperature Shift, Ta=25°C

1. Voltage[RMS] vs. Color Temperature Shift -100V

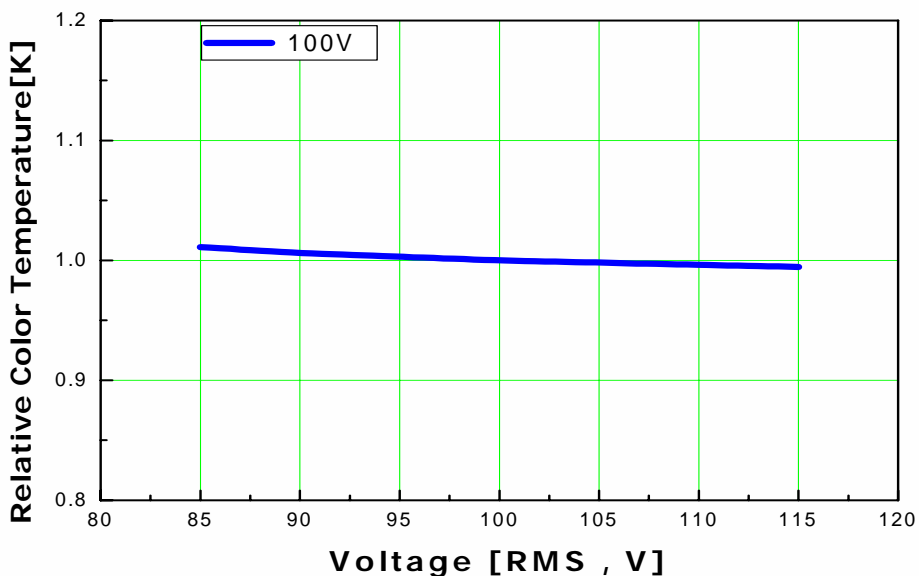

2. Voltage[RMS] vs. Color Temperature Shift -110V

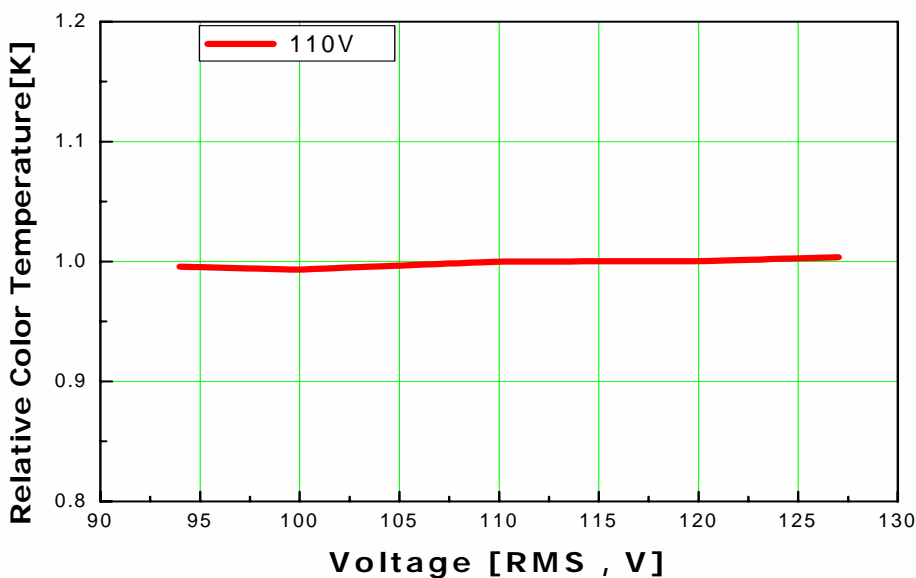

Relative Flux – Lead temperature characteristics

1. Pure white

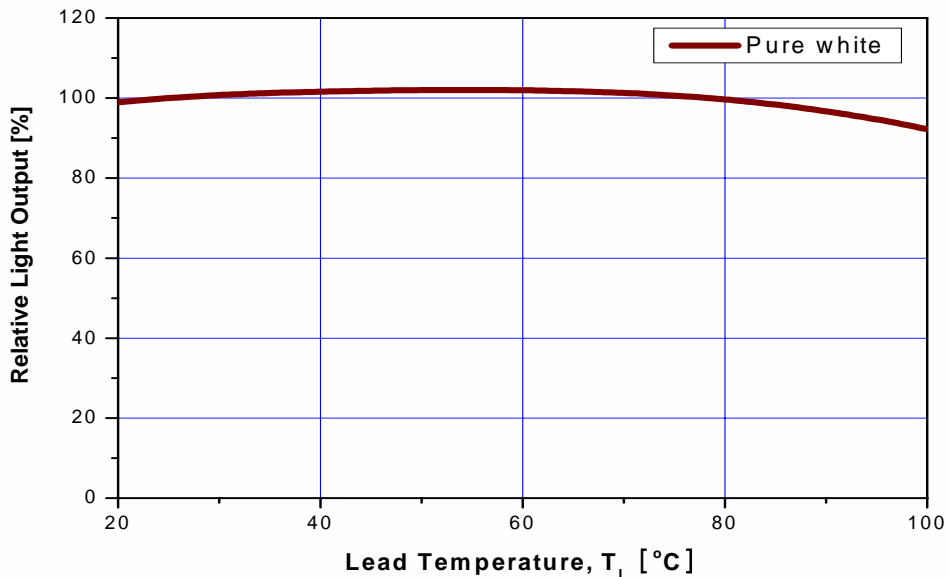

2. Warm white

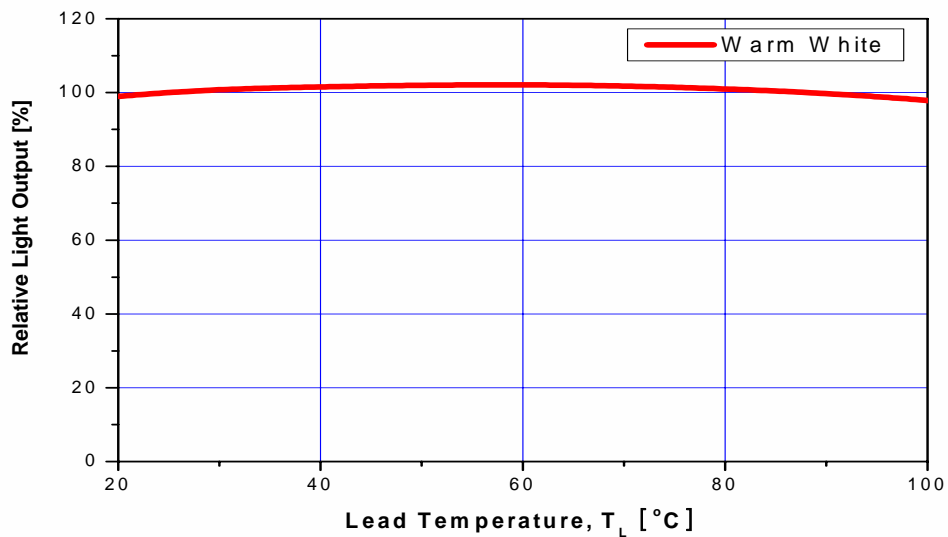

Typical Dome Type Radiation pattern

1. Pure White, Warm White

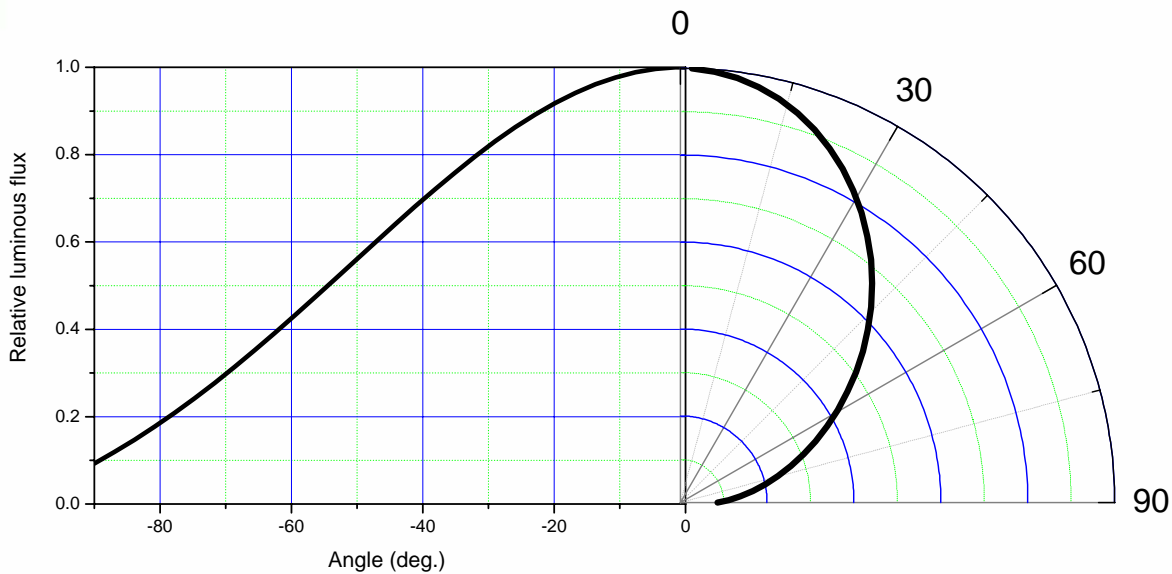

Acriche Binning structure graphical representation

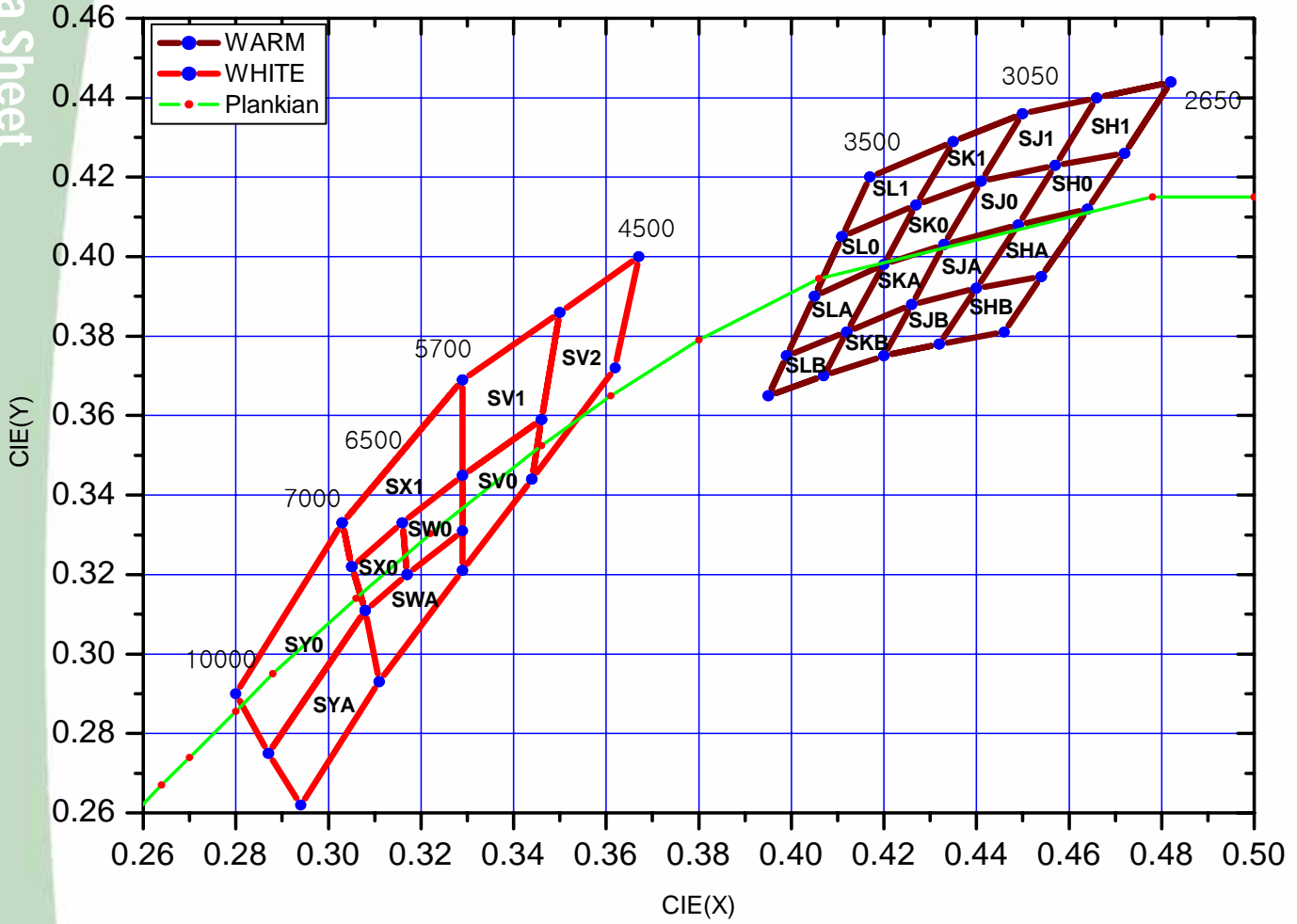

PCB type Reel Packaging

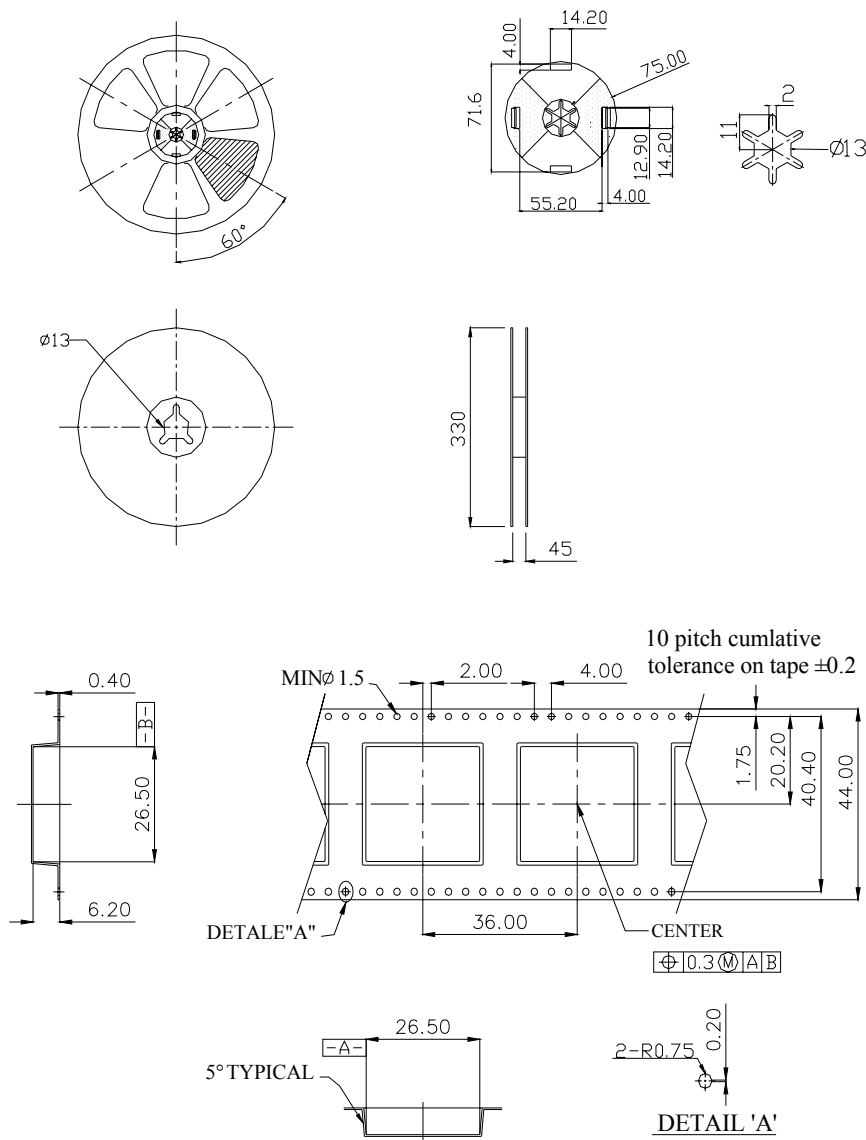

Note :

1. The number of loaded products in the reel is 100ea
2. All dimensions are in millimeters (tolerance : ± 0.2)
3. Scale none

*The appearance and specifications of the product may be changed for improvement without notice.

Packaging Structure

Aluminum Vinyl Bag

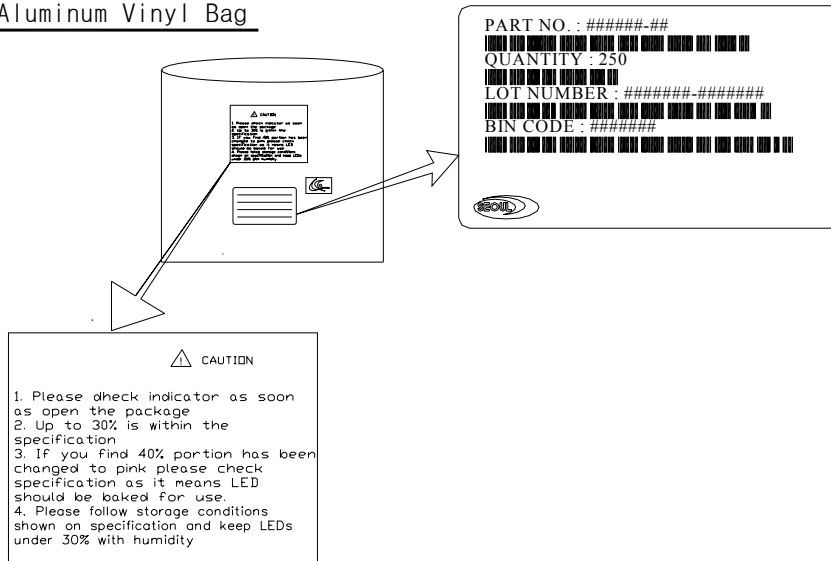

Outer Box

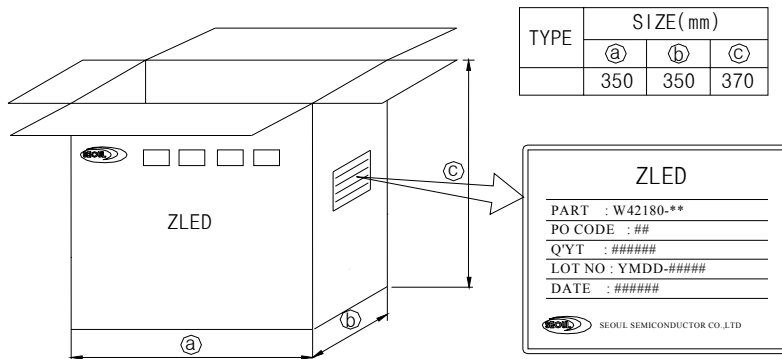

Note :

1. 6 reels are loaded in box
2. Scale none
3. For more information about binning and labeling, refer to the Application Note - 1

Precaution for use

- [1] Acriche series run on high voltage such as 110 V or 220 V.
- [2] Please don't touch the PCB surface, which has built-in terminals and chips, with your hands or metals, while Acriche series is running.
- [3] Please don't add or change wires, while Acriche series is running.

Handling of silicone resin for LEDs

- [1] Acriche series is encapsulated by silicone resin for the highest flux efficiency.
- [2] Notes for handling of Silicone resin Acriche series.
- [3] Avoid touching silicone resin parts especially by sharp tools such as Pincette (Tweezers).
- [4] Avoid leaving fingerprints on silicone resin parts.
- [5] Dust sensitivity silicone resin need containers having cover for storage.
- [6] When populating boards in SMT production, there are basically no restrictions regarding the form of the pick and place nozzle, except that mechanical pressure on the surface of the resin must be prevent.
- [7] Please do not force over 3000 gf impact or pressure diagonally on the silicon lens. It will cause fatal damage of this product.
- [8] Please do not recommend to cover the silicone resin of the Acriche series with other resin (epoxy, urethane, etc).